

SIRUBA®

銀箭牌工業用縫紉機
INDUSTRIAL SEWING MACHINE

UF918/UF918 WITH TRIMMER

零件圖 PARTS LIST



CE

 高林股份有限公司
KAULIN MFG. CO., LTD.

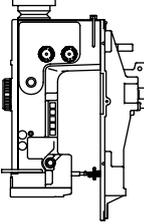
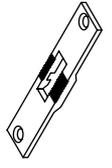
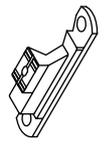
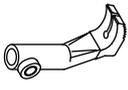
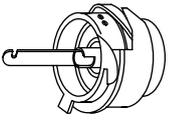
								
MODEL	SUB-CLASS	NEEDLE PLATE	FEED DOG	OUTER PRESSER FOOT	INNER PRESSER FOOT	HOOK ASM	BOBBIN	NEEDLE
機型	規格	針板	送具	外押具	內押具	梭頭	梭子	針號
UF918-X2	厚布料	E680	D680	P681	P680	G175	G308	DP17#22
UF918-X2-12P		E680	D680	P681	P680	G175	G308	DP17#22

PARTS LIST FOR UD GROUP

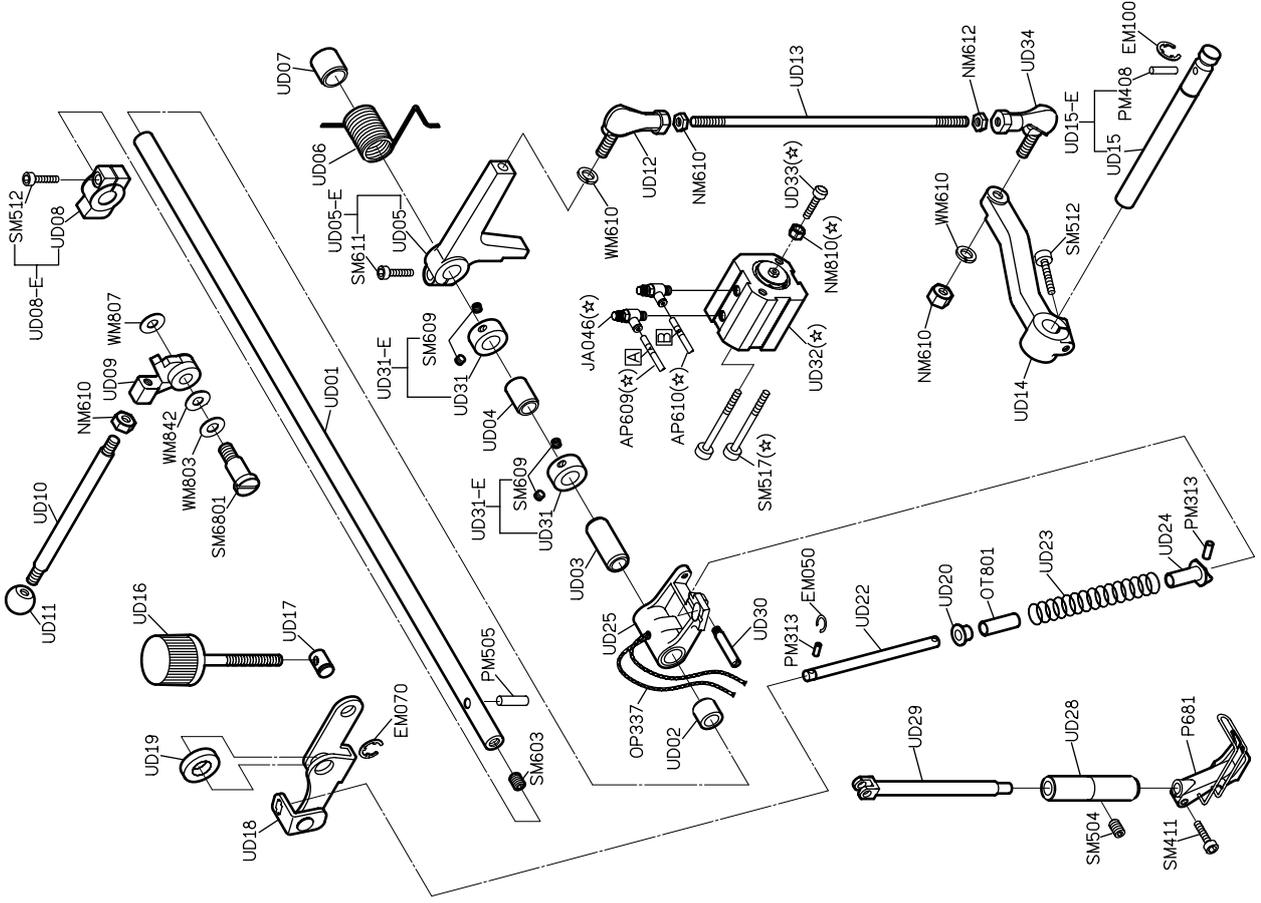

★USE FOR UF918 TRIMMER
 ★USE FOR UF918 TRIMMER

PARTS LIST FOR UE GROUP

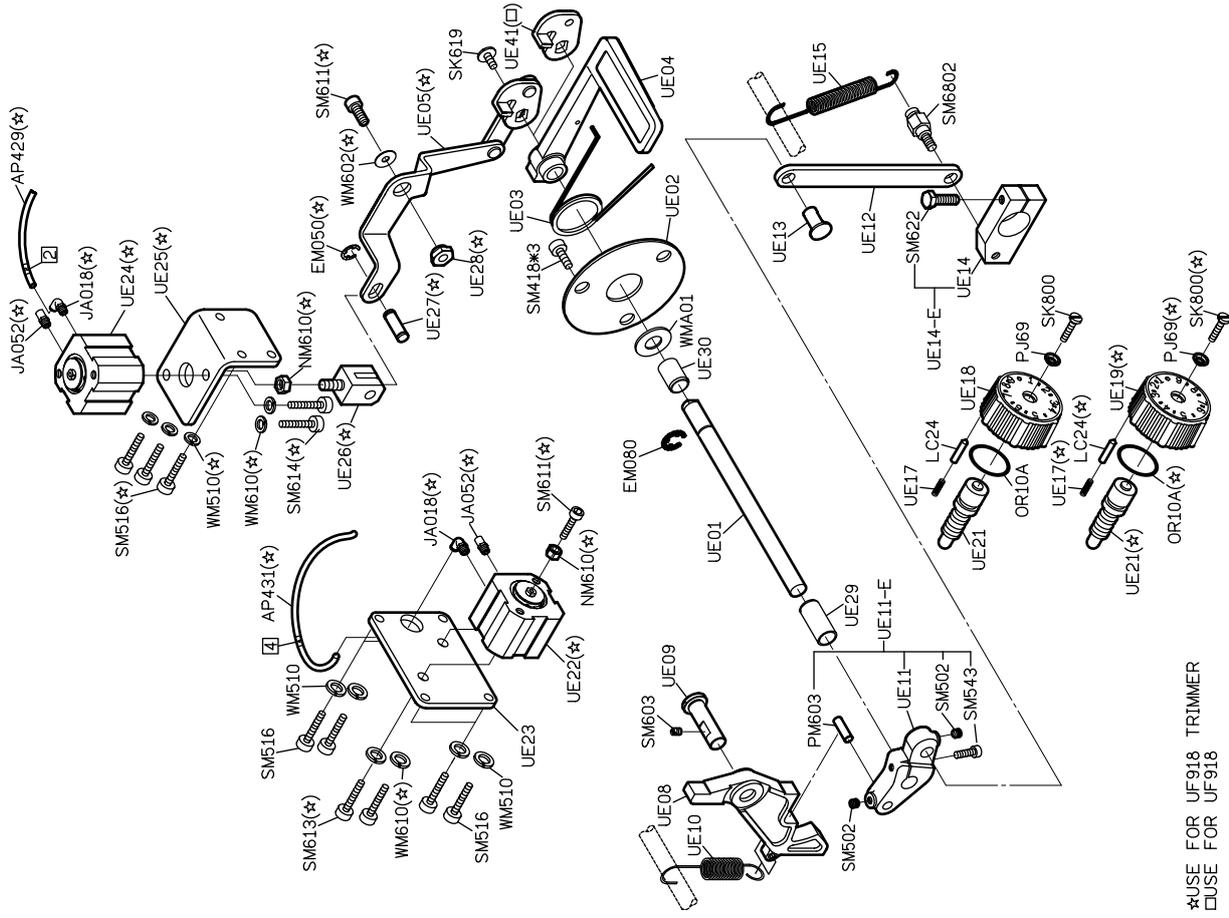

★USE FOR UF918 TRIMMER
 ★USE FOR UF918 TRIMMER

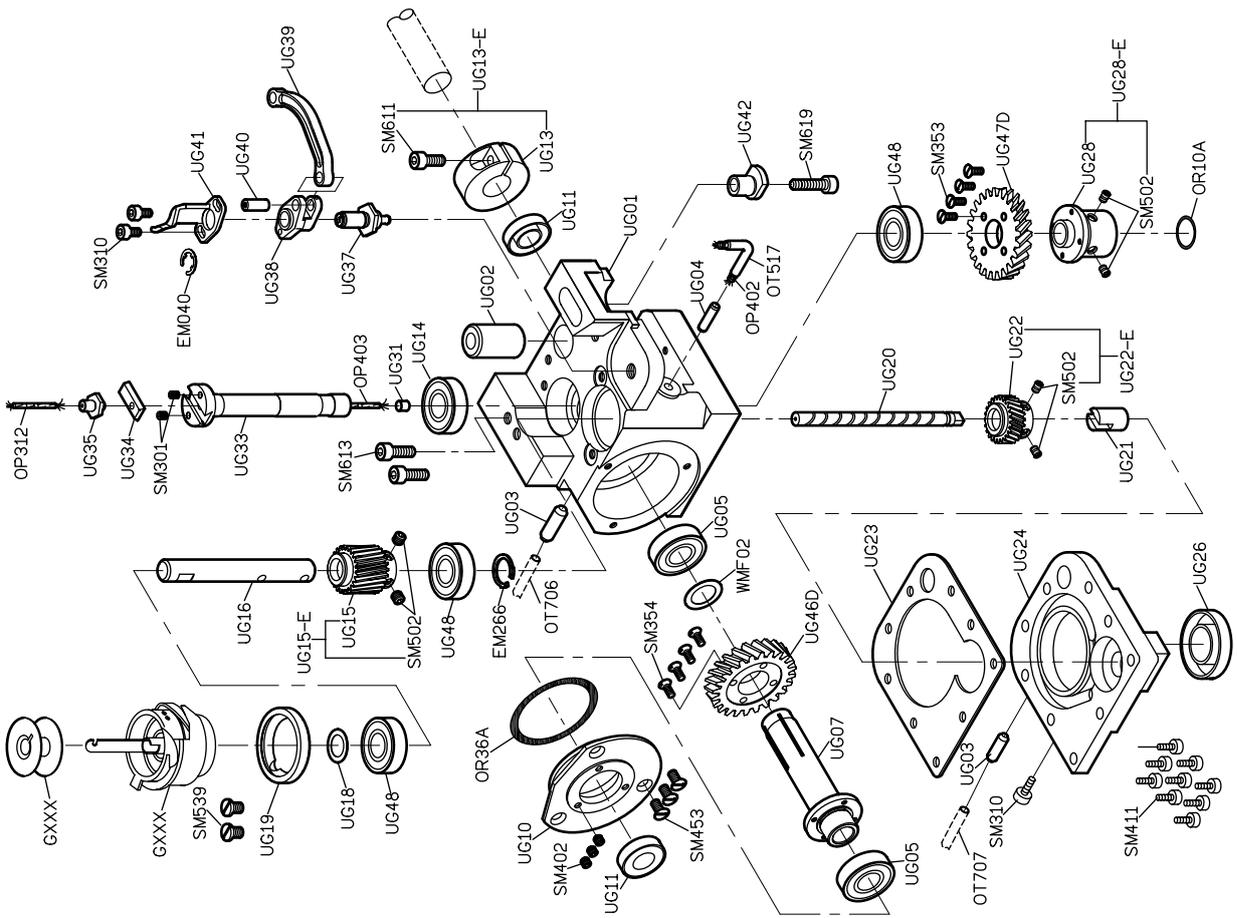

PARTS LIST FOR UG GROUP

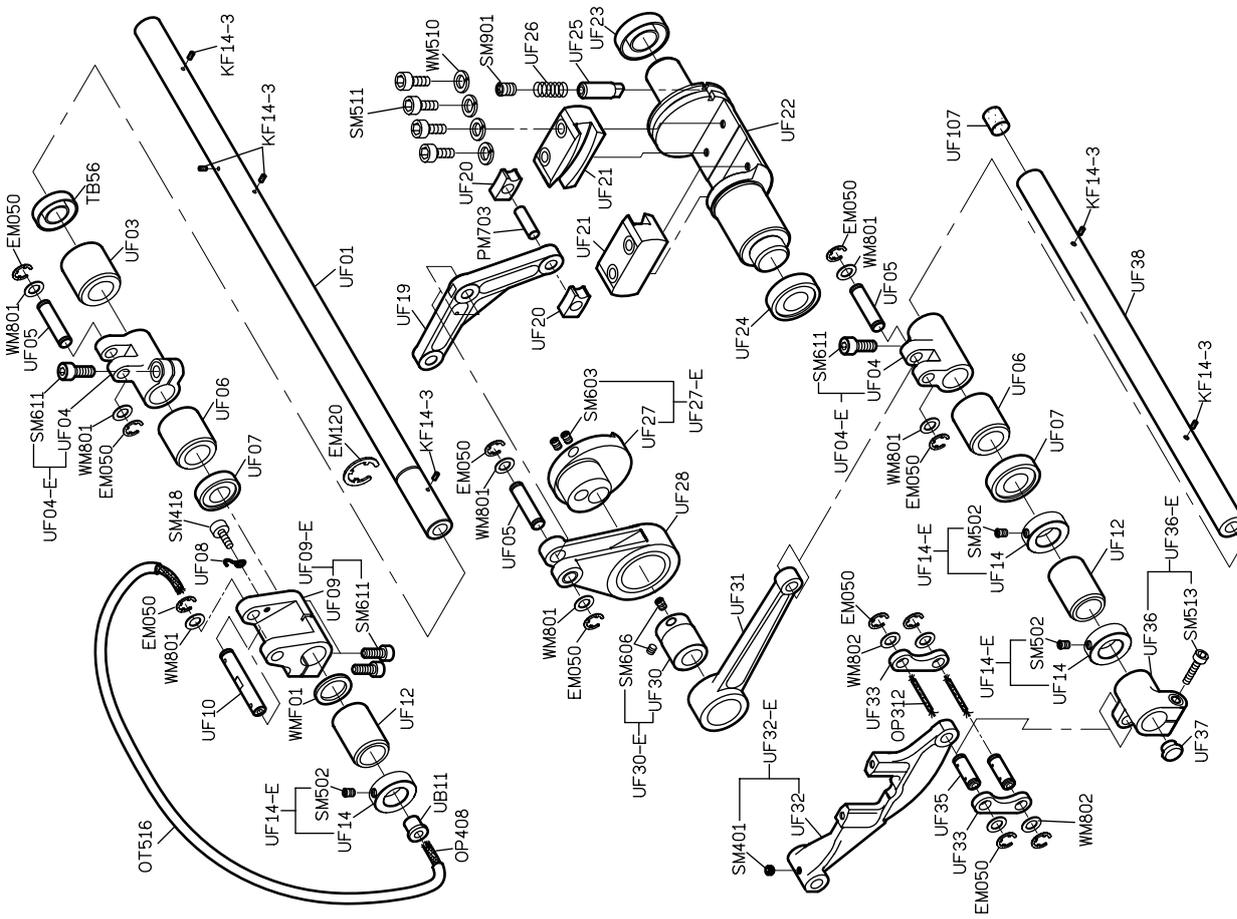

PARTS LIST FOR UF GROUP

PARTS LIST FOR UM (TRIMMER) GROUP

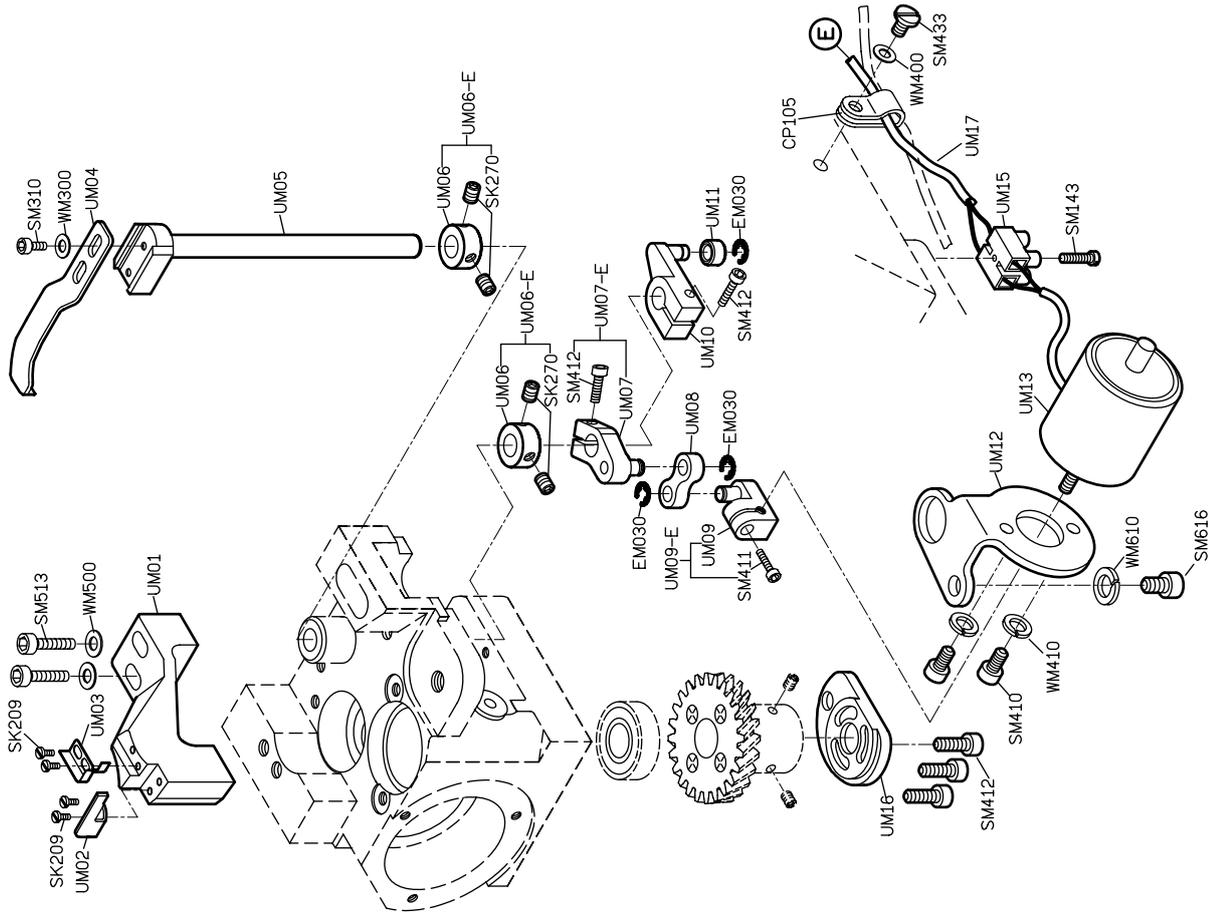

PARTS LIST FOR UL GROUP

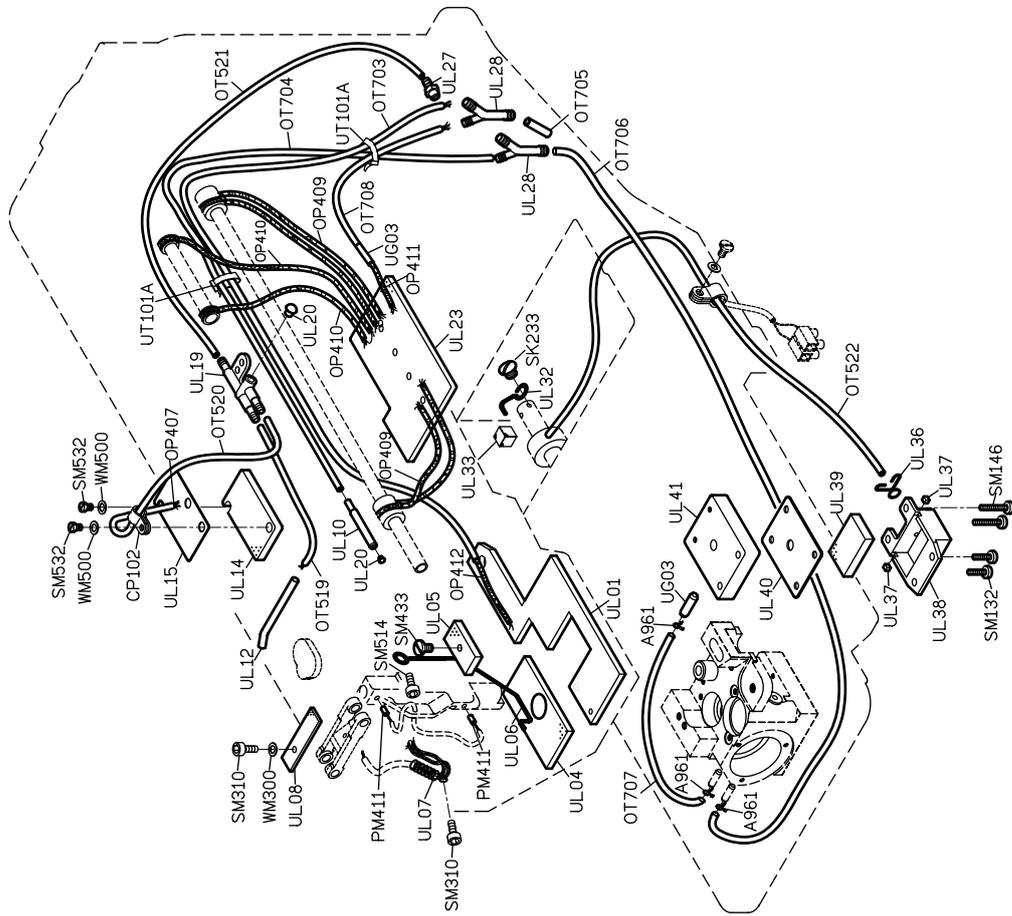

UN05-E(□)

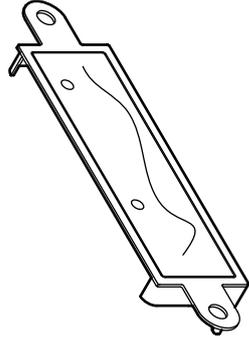

UN01-A

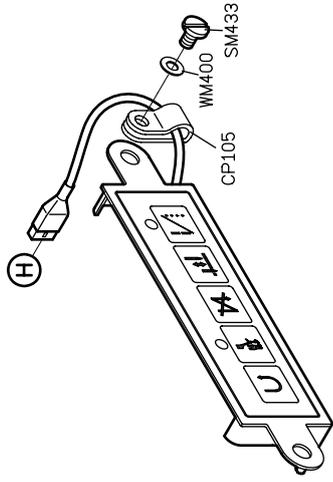

C300-A

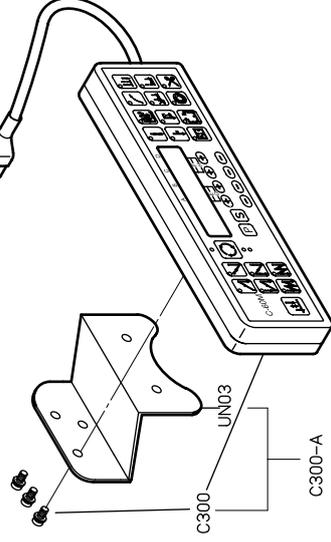

UN04-A

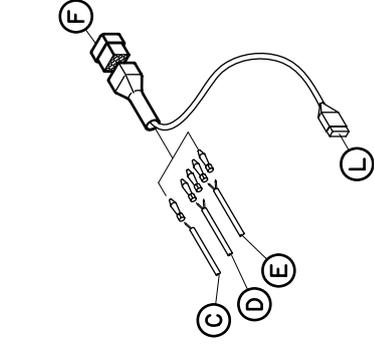

UT121-A1

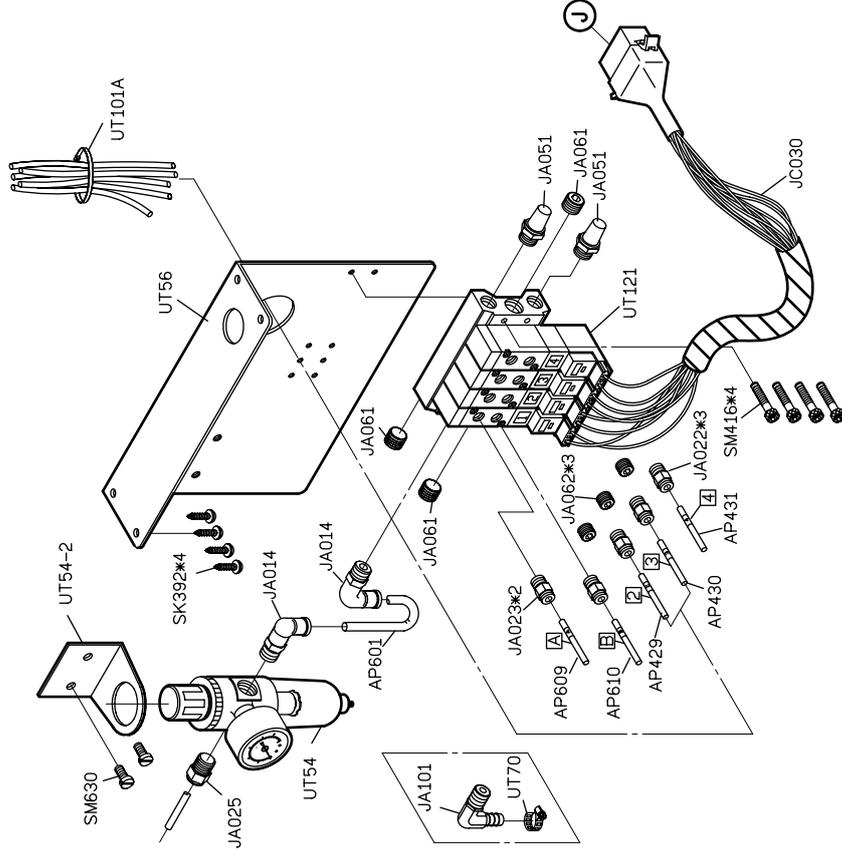

DUSE FOR UF918

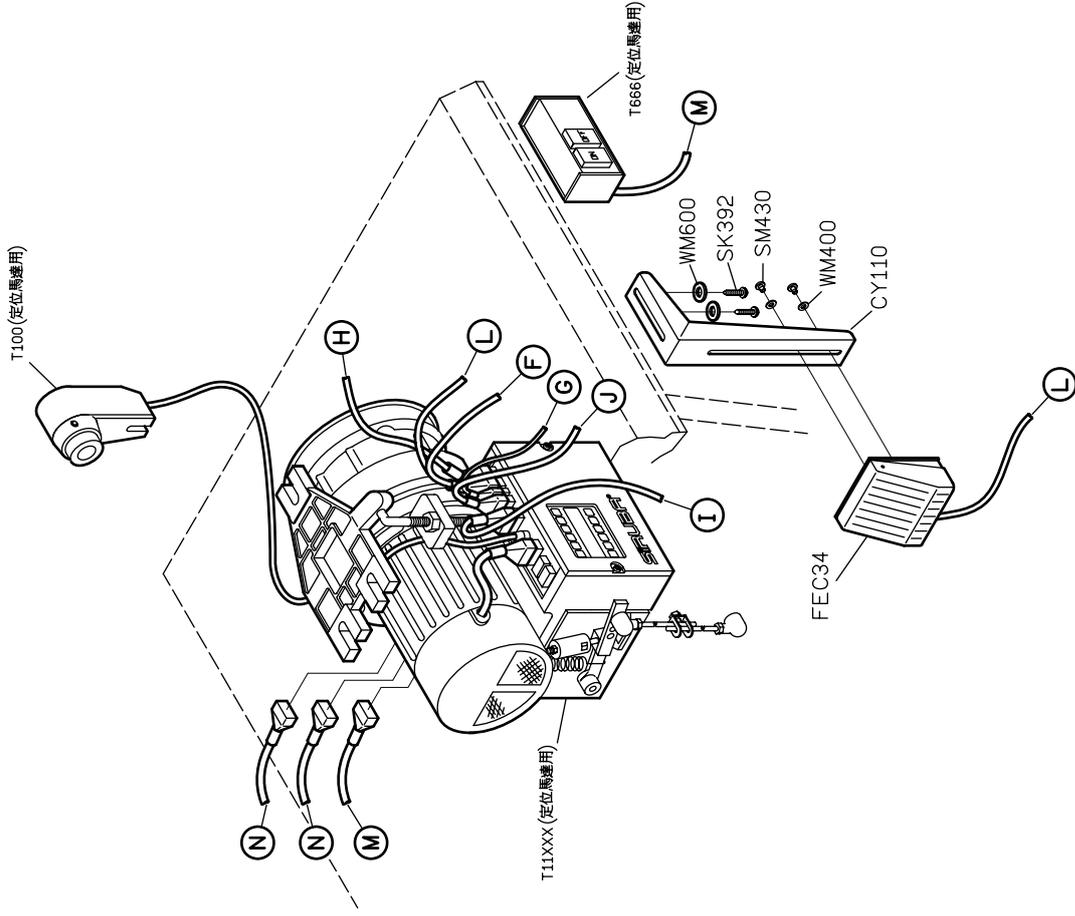

MY09
六角扳手
1.5



KY10
六角扳手
2



MY10
六角扳手
2.5



MY11
六角扳手
3



MY12
六角扳手
4



KY11
六角扳手
5



MY13
一字扳手

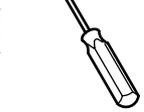

KY17
一字扳手

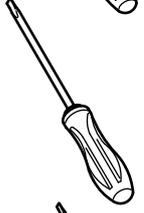

KY16
一字扳手

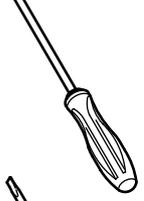

KY18
夾子



針*2



YM03*2
緩衝墊



YM02*2
緩衝墊



KZ03*1
乾燥劑



G308*3
梭子



L Y02
支撐架



KY03
油壺



L Y05*2
後鈕

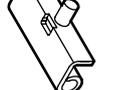

YM04*2
後扭座

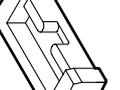

MY01
防塵罩



LY21-A
油罐



KY26F
配件袋



TY16
油壺

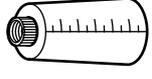

UY01
油槽

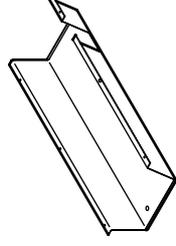

UY05
說明書

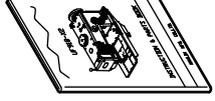

UY06
零件圖

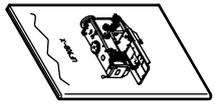

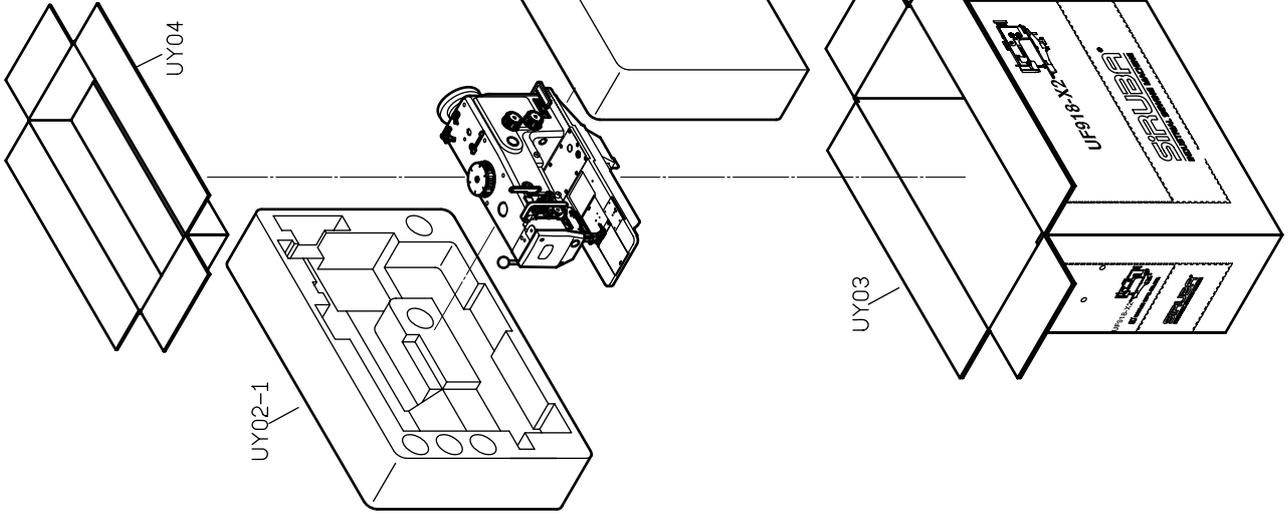

UY06-E

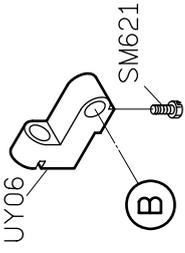

LM20-A

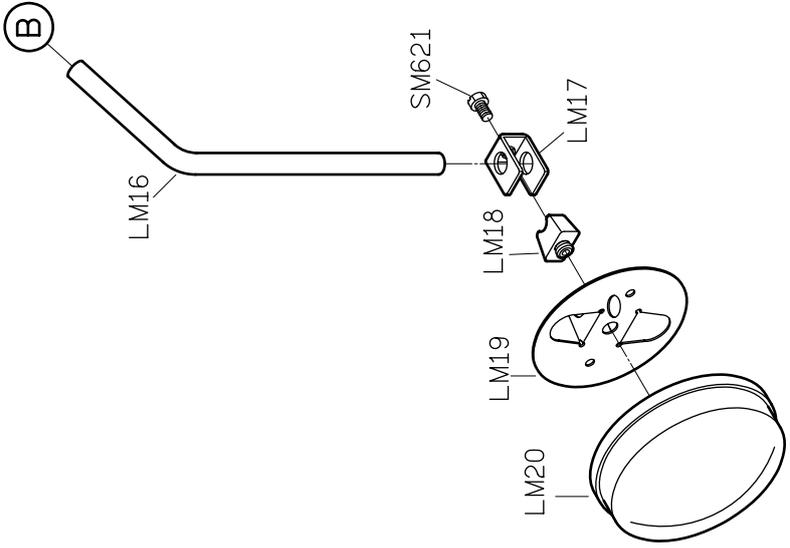

PARTS LIST FOR THREAD STAND GROUP

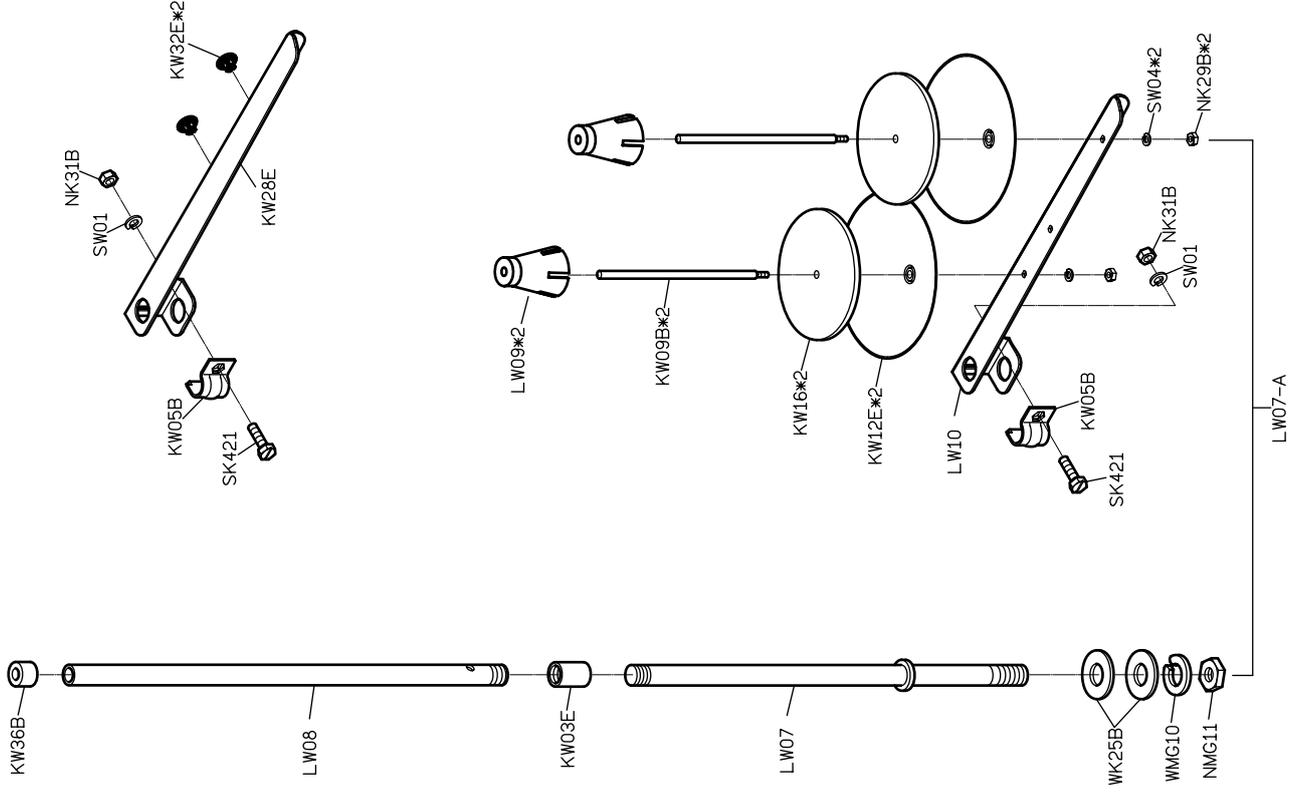



UF918/UF918^{WITH} TRIMMER

高林股份有限公司 KAULIN MFG. CO., LTD.